

Preaction Sprinkler
Double safety for
water sensitive areas

*Cool down.
Fire Protection by*

MINIMAX

SPRINKLER-

protection – for water sensitive areas

Server rooms, archives and other water-sensitive areas with delicate equipment have one thing in common: extinguishing water should only be sprayed there, even if it is really burning. Under these circumstances preaction sprinklers offer double safety against unwanted activation of a sprinkler system. To improve safeguards against erroneous activation, each preaction sprinkler unit consists of a housing with two sprinklers. Only when both of these sprinklers are opened will water be released.

If a sprinkler is damaged, for example during works on building facilities, water may leak, causing damage to the building or equipment. Particularly in areas with water-sensitive equipment, which can have very severe consequences for the organization, for example the failure of the IT system.

Preaction dry systems, which include an additional fire detection system, are recommended for the protection of sensitive areas with a sprinkler system. Preaction dry systems only release the extinguishing water if, in addition to the opening of a sprinkler, the fire detection system reacts. This offers a high level of security against erroneous releases but does require additional fire detection equipment, a separate alarm valve station, more pipe line and a dedicated pressurized air supply. This type of system is therefore suitable for the protection of large water-sensitive areas.

If however a small water-sensitive area within a building is to be protected with an existing or planned sprinkler system, the use of preaction sprinklers represents a simple alternative. These special sprinklers can be simply connected to the existing or planned sprinkler pipework, providing double safety against the unwanted release of the sprinkler system, while offering the same fire protection. Before sprinkling water is released, both sprinklers must always release a preaction sprinkler unit. The risk of water leakage and related damage through accidental damage to a sprinkler is therefore dramatically reduced.

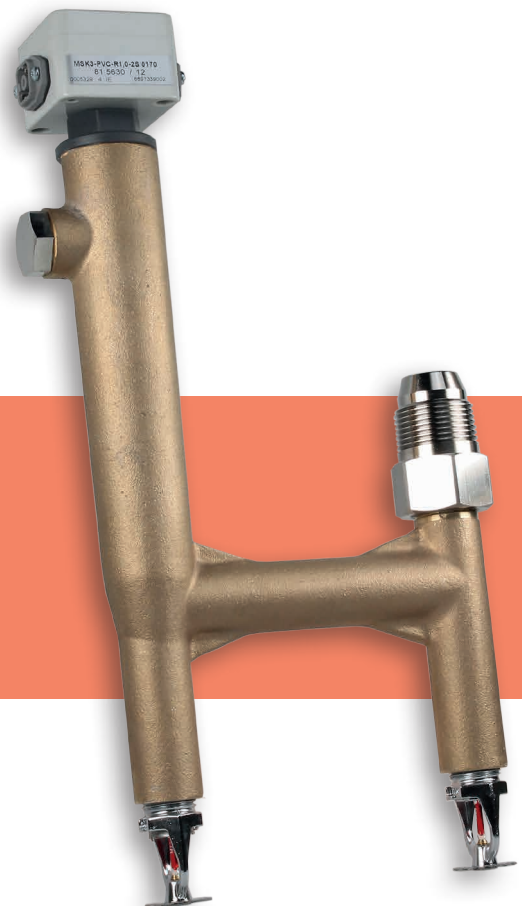

INTEGRATION

Simple, safe and flexible

Preaction sprinklers are installed in sprinkler systems with wet and dry pipework in exactly the same way as conventional sprinklers. A major difference however is that preaction sprinklers can be wired to a monitoring panel. The electrical elements of the preaction sprinklers serve solely for monitoring and fault display: their release is purely mechanical.











FMZ 5000 fire detection and extinguishing control panels are used for monitoring. Alternatively a small, specially designed compact control panel is available that displays optically and audibly directly in the sensitive area if at least one sprinkler of a preaction sprinkler unit has released. Accidental damage is thus indicated and countermeasures can be taken before any damage occurs.

A monitoring panel can monitor one or, in parallel, even several preaction sprinklers and show their operating status.

As preaction sprinklers can be connected to the pipework of an existing sprinkler system, retrofits and changes of use in existing buildings with sprinkler protection are also very easily achieved with them.

Versions with NPT- and GNP threads permit simple integration into existing wet- or dry pipework. Preaction sprinklers have a low K factor and low minimum operating pressure, which also simplifies hydraulic integration into existing systems. As assembly openings can be quickly and inconspicuously concealed by special covers, preaction sprinklers can be integrated harmoniously and discreetly into the look of the ceiling.

Protection of water-sensitive areas

-  Water-sensitive area
-  Engineering room
-  Wet alarm valve station
-  Preaction dry pipe alarm valve set with pressurized air supply unit
-  Fire detection and extinguishing control panel
-  Preaction sprinkler monitoring panel
-  Detector line with fire detector
-  Pipework (wet) with sprinkler
-  Pipework (dry) with sprinkler
-  Pipework (wet) with preaction sprinkler

Preaction dry system

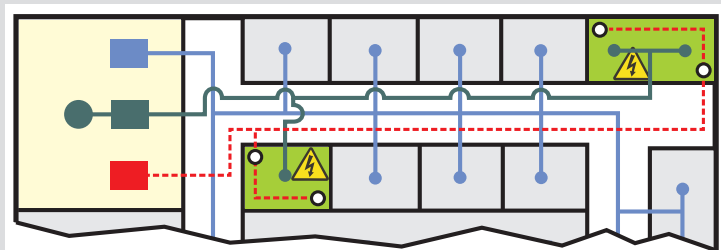

Preaction sprinklers

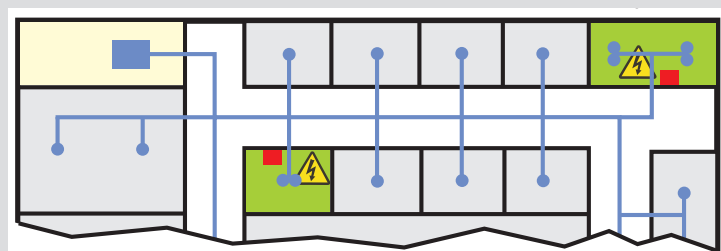

FUNCTION

with double safety

Construction

Preaction sprinklers consist of a cast housing with two separately arranged sprinklers. The preaction sprinkler for wet installations is fitted with a monitoring switch and in the version for dry systems is additionally fitted with a pressure switch. This allows the relay of signals to a monitoring panel if one of the two sprinklers is opened.

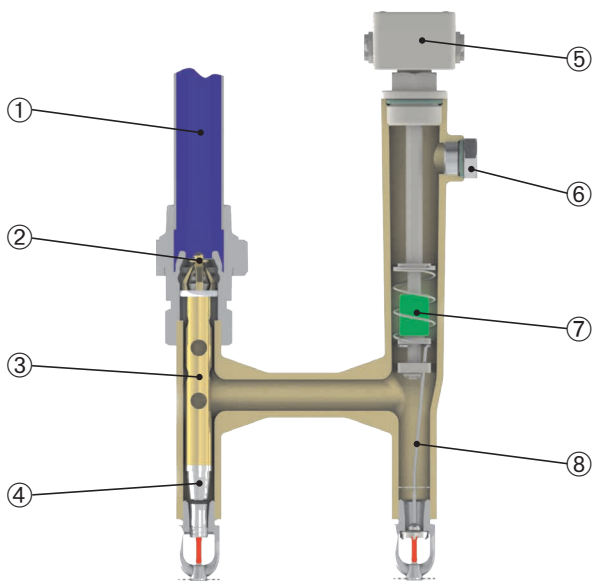

- ① Sprinkler system connection
 - ② Seal
 - ③ Spacer pipe
 - ④ Sealing cone
 - ⑤ Monitoring switch
 - ⑥ Pressure switch connection*
 - ⑦ Float
 - ⑧ Spacer
- *only for dry systems

Function

① Release of sprinkler A – fault

The release of sprinkler A cancels the supporting effect of the seal and the spacer pipe drops down.

▶ When connected to wet pipework

water flows into the preaction sprinkler for wet systems. However, the sealing cone at the lower end of the spacer pipe prevents escape of water from the opened sprinkler A. The incoming water allows the float to rise and immediately sends a message to the monitoring panel.

▶ When connected to dry pipework

compressed air flows in the preaction sprinkler for dry systems. This activates the pressure switch and a message is sent to the monitoring panel.

② Release of sprinkler B – fault

When sprinkler B is released, the spacer with the float falls downwards. The monitoring switch sends a message to the monitoring panel.

③ Release of sprinklers A and B – fire

When both sprinklers are released, extinguishing water escapes from sprinkler B as intended and fights the fire. Sprinkler A remains sealed by the sealing cone. The fire alarm is activated via the alarm pressure switch of the upstream alarm valve station.

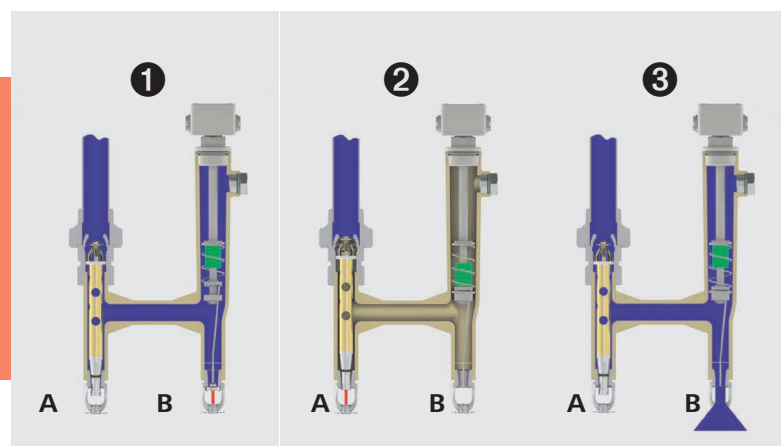

APPLICATIONS

A class of its own

Preaction sprinklers are particularly suitable for the protection of water-sensitive areas with sensitive equipment, especially in installations in which sprinkler systems are already installed.

Depending on the version, there are approvals from VdS Schadenverhütung and FM Global that confirm the effectiveness and reliability of preaction sprinklers.

Examples of use

- ▶ Smaller server-, IT- and control rooms
- ▶ Electrical switchgears
- ▶ Information- and communication facilities
- ▶ Areas in archives, libraries and galleries
- ▶ Rooms in museums
- ▶ Sauna areas
- ▶ Workstations with screens
- ▶ Production facilities



Special design: Preaction sauna sprinkler

Preaction sauna sprinklers combine two different release temperatures (141 °C and 182 °C) in one preaction sprinkler unit. When the 141 °C sprinkler is released, extinguishing water will not yet be released, but a signal is sent, on the basis of which the sauna users are asked to leave and the sauna stove can be automatically turned off. It is only when the second sprinkler is activated that a fire can be assumed and extinguishing water released.



BENEFITS

At a glance

There are many reasons for using Minimax preaction sprinklers:

- ▶ Additional safeguard when a sprinkler is accidentally damaged - allows the fire protection of areas with water-sensitive equipment with a sprinkler system
- ▶ Simple alternative to preaction dry system for small areas - additional fire alarm equipment, separate alarm valve station, more pipe line and dedicated pressurized air supply are not required
- ▶ Simple retrofit - versions with NPT-and GNP threads allow simple integration into existing sprinkler systems with wet or dry pipework, while the lower K factor of the preaction sprinklers facilitates hydraulic balancing
- ▶ Harmonious and discreet integration into the look of the ceiling - assembly openings can be quickly and inconspicuously concealed
- ▶ Approvals by VdS Schadenverhütung and FM Global confirm the effectiveness and reliability of the preaction sprinklers
- ▶ Compact monitoring panel available for display and messaging of the operating status, decentralized near the protected area or at central, permanently manned location
- ▶ Wiring system with reverse polarity-protected connectors and preassembled cables for quick and easy connection of preaction sprinklers to the monitoring panel



Distributør av Minimax
systemer og produkter i Norge

Maxitech.no kontakt@maxitech.no



Pictures:

Title: Pillar Workshop

Page 5: Fotolia © Pavel Losevsky, Fotolia © JPS,
Fotolia © industrieblick, Fotolia © Nettle

You can find more detailed information in the technical documentation.
Subject to technical modification without prior notice.